

**Profec Gängad fläns stål
zinkpläterad DN150 x 6" DIN
fläns x invändig gänga DN150
PN10/16 (1080220)**



TEKNISKA SPECIFIKATIONER

Material	stål
Ytbehandling	zinkpläterad
Anslutning	DIN fläns x invändig gänga
DIN Standard	DIN 2566
Fläns	PN10/16
Storlek	DN150 x 6"
Bult	
DN	150
Diameter	168,3 mm
Yttre Ø	285 mm
Vikt	7.92 kg
Tjocklek	22 mm
Bulthål	22 mm
Hål	8

DIMENSIONER

O	22 mm
---	-------

PCD

240 mm

ØDi-1

6 "

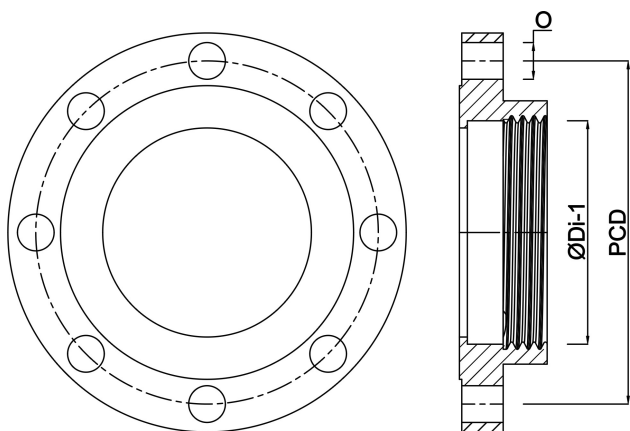

Genererad den: 28/05/2026

Bevo Nordic A/S
Pakhusgården 54
5000 Odense C
Danmark
+45 66 19 25 45
info@bevo.dk
<http://www.bevo.com>