

**Profec Gängad fläns stål
zinkpläterad DN80 x 3" DIN
fläns x invändig gänga DN80
PN10/16 (1080217)**



TEKNISKA SPECIFIKATIONER

Material	stål
Ytbehandling	zinkpläterad
Anslutning	DIN fläns x invändig gänga
DIN Standard	DIN 2566
Fläns	PN10/16
Storlek	DN80 x 3"
Bult	
DN	80
Diameter	88,9 mm
Yttre Ø	200 mm
Vikt	4.12 kg
Tjocklek	20 mm
Bulthål	18 mm
Hål	8

DIMENSIONER

O	18 mm
---	-------

PCD

160 mm

ØDi-1

3 "

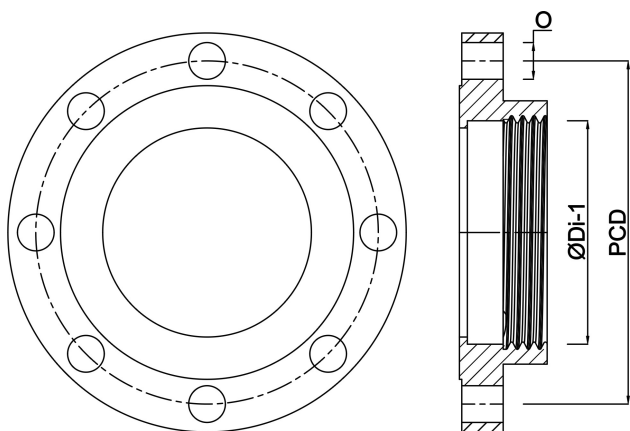

Genererad den: 24/05/2026

Bevo Nordic A/S
Pakhusgården 54
5000 Odense C
Danmark
+45 66 19 25 45
info@bevo.dk
<http://www.bevo.com>