

Profec Kulventil PVC-U 20 mm limsocket 16bar DN15 grå type 2000 (0111376)



TEKNISKA SPECIFIKATIONER

Färg grå

Typ 2000

Material PVC-U

Funktion handtag

Handtagsfärg röd

Handtagsmaterial PVC-U

Hus konstruktion 3-delt

Materialhus PVC-U

Packningsmaterial PE/EPDM

Anslutning limsocket

Temperatur intervall 10°C - 60°C

Storlek 20 mm

DN 15

Tryck 16 bar

DIMENSIONER

Ct-1 53.5 mm

Lb 84 mm

R 63 mm

ØDf 15 mm

ØDi-1 20 mm

ØDi-2 20 mm

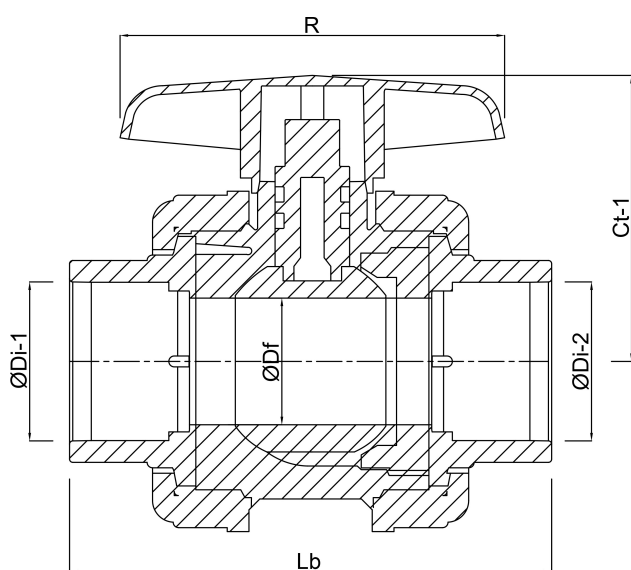

Genererad den: 23/05/2026

Bevo Nordic A/S
Pakhusgården 54
5000 Odense C
Danmark
+45 66 19 25 45
info@bevo.dk
<http://www.bevo.com>