

**Svetsböj 90° stål 33,7 mm x
33,7 mm x 2,6 mm svetsning
(1180025)**



TEKNISKA SPECIFIKATIONER

Material stål

Anslutning svetsning

DIN Standard DIN 2605

Norm 3S

Storlek 33,7 mm

Vägg tjocklek 2,6 mm

DIMENSIONER

Cb-1 37 mm

Cb-2 37 mm

ØDo-1 33.7 mm

ØDo-2 33.7 mm

β 90 °

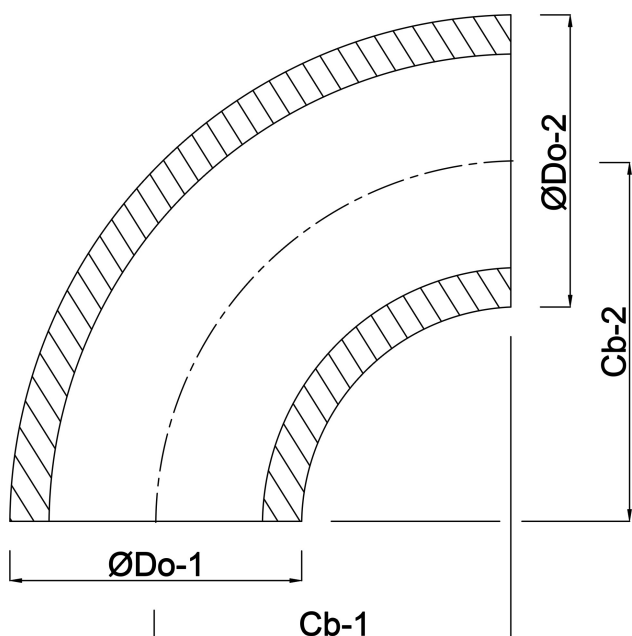

Genererad den: 24/05/2026

Bevo Nordic A/S
Pakhusgården 54
5000 Odense C
Danmark
+45 66 19 25 45
info@bevo.dk
<http://www.bevo.com>