

**Hydro-S Vridspjäll PVC-U 160
mm fläns 10bar DN150 grå
PN10 type 7500 (7014384)**



hydro-s

TEKNISKA SPECIFIKATIONER

Färg grå

Typ 7500

Material PVC-U

Funktion handtag

Handtagsfärg blå

Material ventil PVC-U

Spindelmaterial stål

Materialhus PP GF

Packningsmaterial EPDM

Anslutning fläns

Fläns PN10

Temperatur intervall 0°C - 40°C

Storlek 160 mm

DN 150

Bredd 66 mm

Tryck 10 bar

Bulthål 24 mm

DIMENSIONER

Ct-1 235 mm

PCD 250 mm

R 258 mm

W-1 66 mm

W-2 115 mm

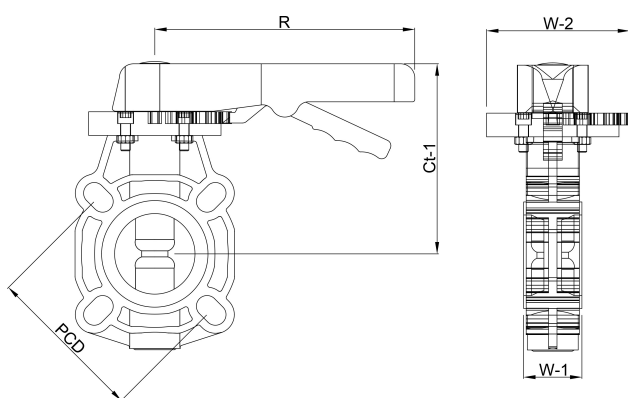

Genererad den: 28/05/2026

Bevo Nordic A/S
Pakhusgården 54
5000 Odense C
Danmark
+45 66 19 25 45
info@bevo.dk
<http://www.bevo.com>