

Profec Fläns stål DN32 x 42,4 mm DIN fläns x svetsning 10bar PN10 (1180233)



TEKNISKA SPECIFIKATIONER

Material	stål
Anslutning	DIN fläns x svetsning
DIN Standard	DIN 2576
Fläns	PN10
Tryck	10 bar
Storlek	DN32 x 42,4 mm
Inner Ø	43,1 mm
Yttre Ø	140 mm
Vikt	1.62 kg
Tjocklek	16 mm
PCD	100 mm
Bulthål	18 mm
Hål	4

DIMENSIONER

O	18 mm
PCD	100 mm

ØDi-1

43.1 mm

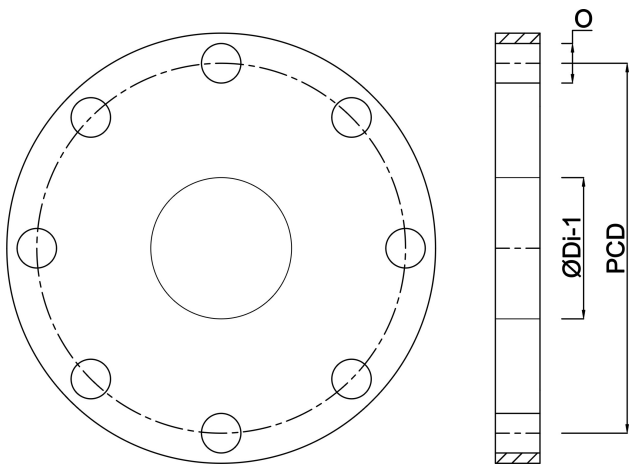

Genererad den: 28/05/2026

Bevo Nordic A/S
Pakhusgården 54
5000 Odense C
Danmark
+45 66 19 25 45
info@bevo.dk
<http://www.bevo.com>