

**Svetsböj 90° stål 76,1 mm x  
76,1 mm x 2,9 mm svetsning  
(1180063)**



# TEKNISKA SPECIFIKATIONER

Material stål

Anslutning svetsning

DIN Standard DIN 2605

Norm 3S

Storlek 76,1 mm

Vägg tjocklek 2,9 mm

## DIMENSIONER

Cb-1 95 mm

Cb-2 95 mm

ØDo-1 76.1 mm

ØDo-2 76.1 mm

β 90 °

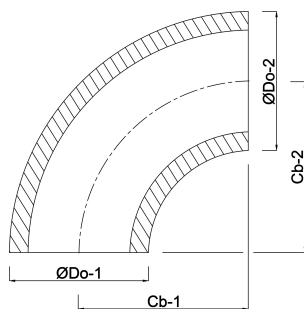

**Genererad den: 14/03/2026**

Bevo Nordic A/S  
Pakhusgården 54  
5000 Odense C  
Danmark  
+45 66 19 25 45  
[info@bevo.dk](mailto:info@bevo.dk)  
<http://www.bevo.com>