

**Profec Gängad fläns stål
zinkpläterad DN40 x 1 1/2" DIN
fläns x invändig gänga DN40
PN10/16 (1080214)**



TEKNISKA SPECIFIKATIONER

Material	stål
Ytbehandling	zinkpläterad
Anslutning	DIN fläns x invändig gänga
DIN Standard	DIN 2566
Fläns	PN10/16
Storlek	DN40 x 1 1/2"
Bult	
DN	40
Diameter	48,3 mm
Yttre Ø	150 mm
Vikt	1.78 kg
Tjocklek	16 mm
Bulthål	18 mm
Hål	4

DIMENSIONER

O	18 mm
---	-------

PCD 110 mm

ØDi-1 1 1/2 "

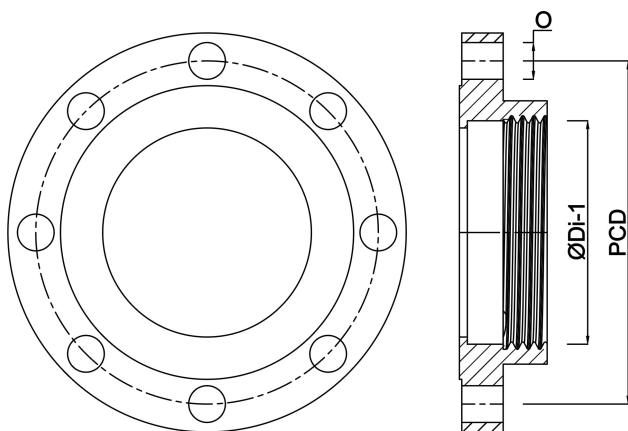

Genererad den: 24/05/2026

Bevo Nordic A/S
Pakhusgården 54
5000 Odense C
Danmark
+45 66 19 25 45
info@bevo.dk
<http://www.bevo.com>