

VDL Unionskoppling PVC-U/PE 90 mm limsocket x koppling SDR17 7,5bar grå (7018211)



V-L Van de Lande

TEKNISKA SPECIFIKATIONER

Färg	grå
Material	PVC-U/PE
Packningsmaterial	EPDM
Anslutning	limsockel x koppling
Klass	SDR17
Tryck	7,5 bar
Storlek	90 mm

DIMENSIONER

L	210 mm
P-2	90 mm
ØDi-2	90 mm
ØDo-1	90 mm

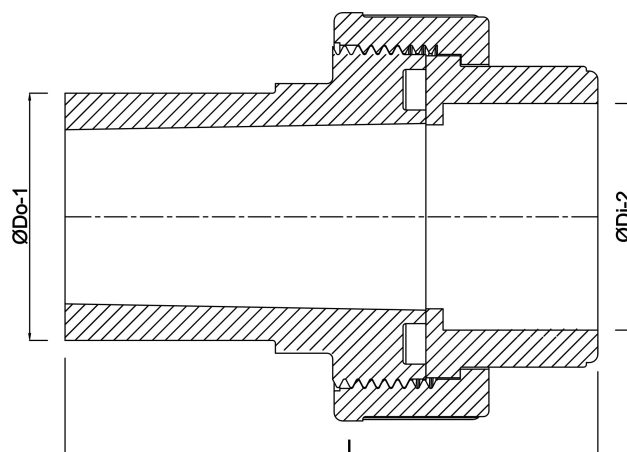

Genererad den: 27/05/2026

Bevo Nordic A/S
Pakhusgården 54
5000 Odense C
Danmark
+45 66 19 25 45
info@bevo.dk
<http://www.bevo.com>