

Profec Fläns stål DN80 x 88,9 mm DIN fläns x svetsning 10bar PN10 (1180237)



TEKNISKA SPECIFIKATIONER

Material	stål
Anslutning	DIN fläns x svetsning
DIN Standard	DIN 2576
Fläns	PN10
Tryck	10 bar
Storlek	DN80 x 88,9 mm
Inner Ø	90,3 mm
Yttre Ø	200 mm
Vikt	3.61 kg
Tjocklek	20 mm
PCD	160 mm
Bulthål	18 mm
Hål	8

DIMENSIONER

O	18 mm
PCD	160 mm

ØDi-1

90.3 mm

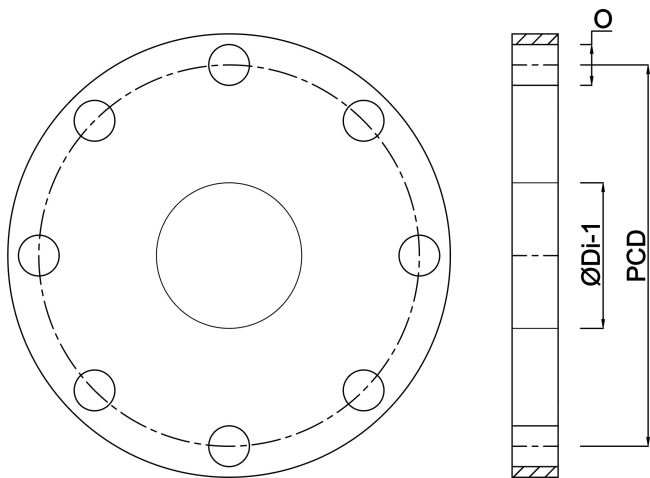

Genererad den: 14/03/2026

Bevo Nordic A/S
Pakhusgården 54
5000 Odense C
Danmark
+45 66 19 25 45
info@bevo.dk
<http://www.bevo.com>