

**DAB Dränkbar pump rostfritt
stål 304 1 1/4" invändig gänga
230VAC rostfritt stål type
Drenag 600 MA med flytande
kontakt (7038200)**



TEKNISKA SPECIFIKATIONER

Färg	rostfritt stål
Material	rostfritt stål 304
Pump body	rostfritt stål 304
Anslutning	invändig gänga
Volt	230VAC
Max temperatur	35 °C
Minste mellantemperatur (kontinuerlig)	0 °C
Max omgivningstemperatur	40 °C
Typ	Drenag 600 MA
Uteffekt	0,6 Hk
Material impeller 1	förstärkt plast
MWC	10 m
Storlek	1 1/4"
Flyter	inkluderad
Effekt	0.45 kW
Max flow rate	13.2 m ³ /h

DIMENSIONER

A 154 mm

C 132 mm

D 50 mm

H 249 mm

H-1 228 mm

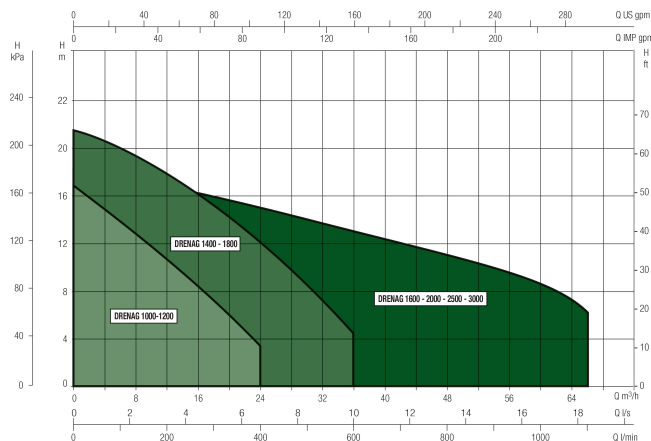
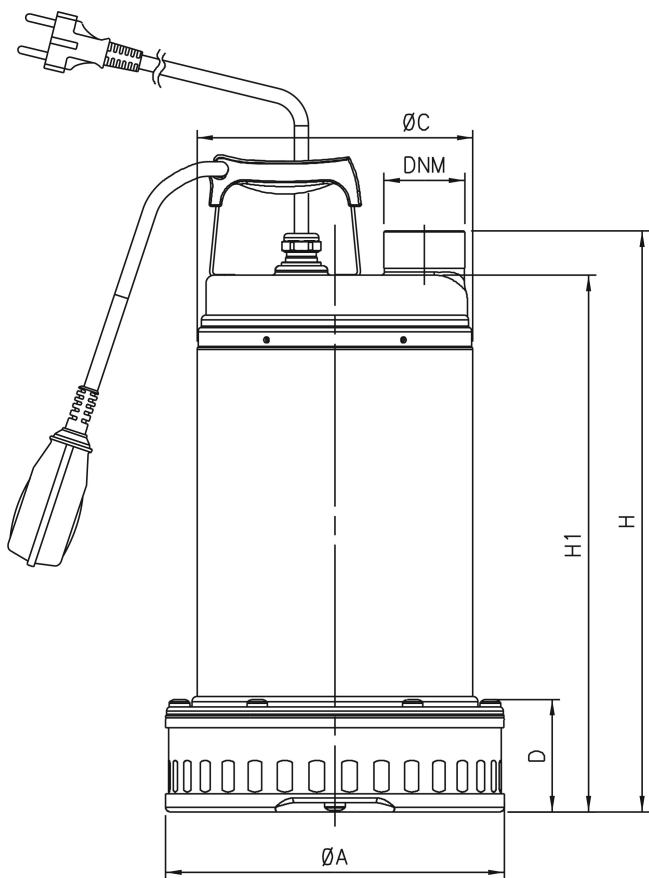

Genererad den: 08/05/2026

Bevo Nordic A/S
Pakhusgården 54
5000 Odense C
Danmark
+45 66 19 25 45
info@bevo.dk
<http://www.bevo.com>