

**Profec Nr. 2 Böj 90° gjutjärn
galvaniserad 1/4" invändig
gänga 25bar DVGW (1000202)**



TEKNISKA SPECIFIKATIONER

Material	gjutjärn
Ytbehandling	galvaniserad
Godkännande	DVGW
Anslutning	invändig gänga
Fitting nr.	Nr. 2
Temperatur intervall	-20°C - 120°C
Tryck	25 bar
Storlek	1/4"

DIMENSIONER

Cb-1	40 mm
Cb-2	40 mm
ØDi-1	1/4 "
ØDi-2	1/4 "
β	90 °

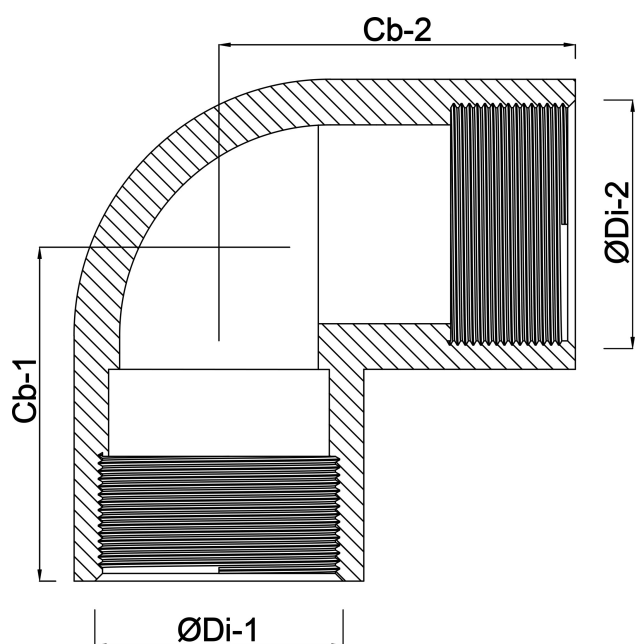

Genererad den: 28/05/2026

Bevo Nordic A/S
Pakhusgården 54
5000 Odense C
Danmark
+45 66 19 25 45
info@bevo.dk
<http://www.bevo.com>