

**Profec Gängad fläns stål  
zinkpläterad DN50 x 2" DIN  
fläns x invändig gänga DN50  
PN10/16 (1080215)**



# TEKNISKA SPECIFIKATIONER

Material	stål
Ytbehandling	zinkpläterad
Anslutning	DIN fläns x invändig gänga
DIN Standard	DIN 2566
Fläns	PN10/16
Storlek	DN50 x 2"
Bult	
DN	50
Diameter	60,3 mm
Yttre Ø	165 mm
Vikt	2.43 kg
Tjocklek	18 mm
Bulthål	18 mm
Hål	4

## DIMENSIONER

O	18 mm
---	-------

PCD

125 mm

ØDi-1

2"

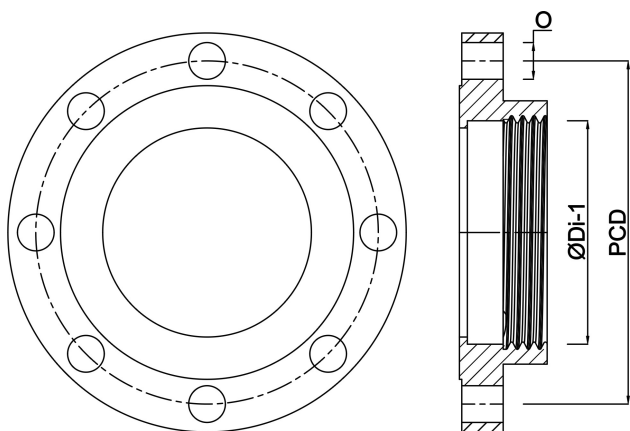

**Genererad den: 24/05/2026**

Bevo Nordic A/S  
Pakhusgården 54  
5000 Odense C  
Danmark  
+45 66 19 25 45  
[info@bevo.dk](mailto:info@bevo.dk)  
<http://www.bevo.com>