

**DAB Dränkbar pump rostfritt
stål 304 1 1/2" invändig gänga
6A 230VAC rostfritt stål type
Drenag 1000 MNA (7038201)**



TEKNISKA SPECIFIKATIONER

Färg	rostfritt stål
Material	rostfritt stål 304
Pump body	rostfritt stål 304
Anslutning	invändig gänga
Volt	230VAC
Max temperatur	35 °C
Minste mellantemperatur (kontinuerlig)	0 °C
Max omgivningstemperatur	40 °C
Typ	Drenag 1000 MNA
Uteffekt	1,36 Hk
Material impeller 1	rostfritt stål 304
MWC	15,3 m
Storlek	1 1/2"
Flyter	inte inkluderad
Effekt	1 kW
Ampere	6 A

Max flow rate

18 m³/h

DIMENSIONER

A 215 mm

C 175 mm

D 71 mm

H 413 mm

H-1 385 mm

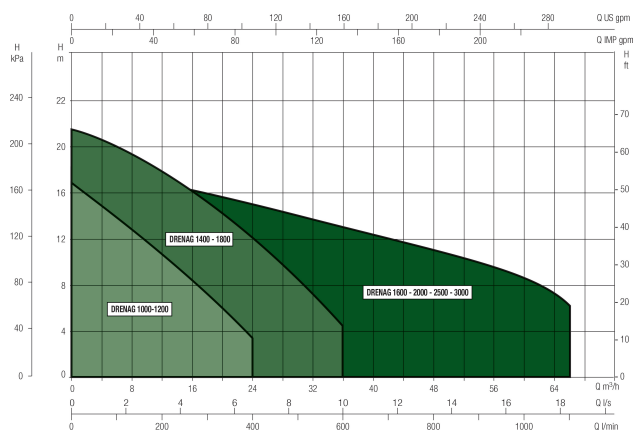
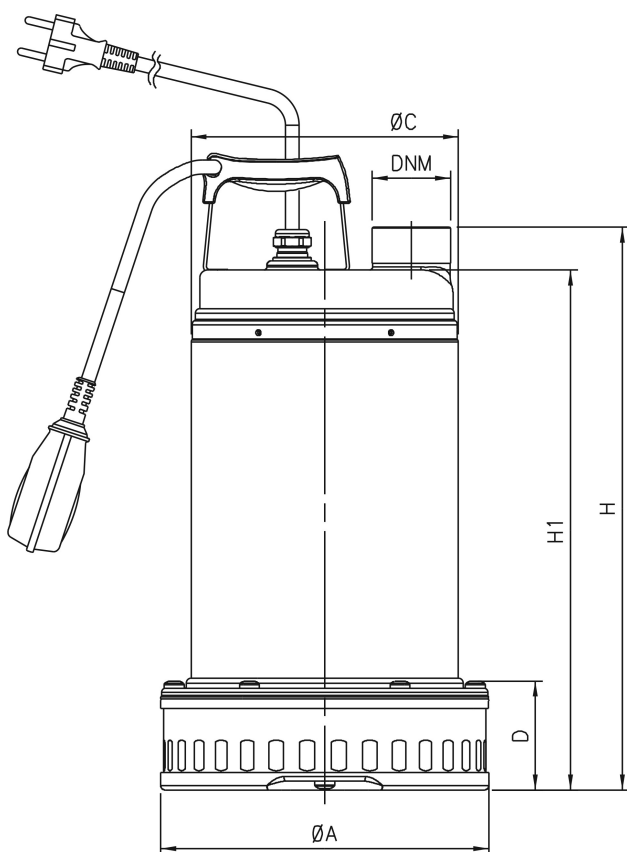

Genererad den: 27/05/2026

Bevo Nordic A/S
Pakhusgården 54
5000 Odense C
Danmark
+45 66 19 25 45
info@bevo.dk
<http://www.bevo.com>