

**Gängad fläns rostfritt stål 316
DN50 x DN50 x 2" DIN fläns x
invändig gänga 16bar DN50
PN16 (0080668)**



TEKNISKA SPECIFIKATIONER

Material	rostfritt stål 316
Anslutning	DIN fläns x invändig gänga
DIN Standard	DIN 2566
Storlek	DN50 x DN50 x 2"
DN	50
Fläns	PN16
Diameter	60,3 mm
Yttre Ø	165 mm
Vikt	2.4 kg
Tjocklek	18 mm
Tryck	16 bar
Bulthål	18 mm
Hål	4

DIMENSIONER

O	18 mm
PCD	125 mm

ØDi-1

2"

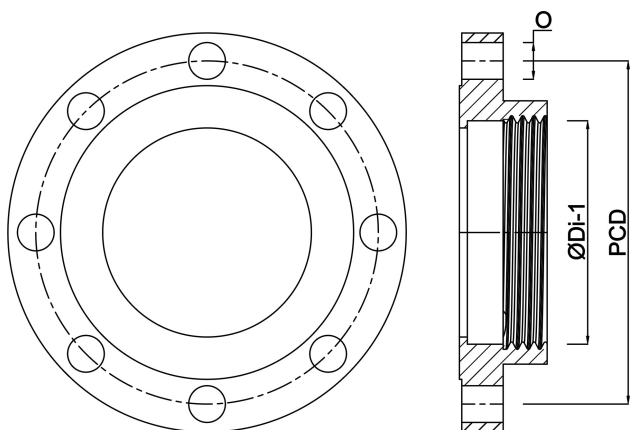

Genererad den: 22/05/2026

Bevo Nordic A/S
Pakhusgården 54
5000 Odense C
Danmark
+45 66 19 25 45
info@bevo.dk
<http://www.bevo.com>