

**Kulventil PVC-U 20 mm
limsocket 10bar DN15 grå type
2000 Teflon (0111906)**



TEKNISKA SPECIFIKATIONER

Färg	grå
Typ	2000 Teflon
Material	PVC-U
Funktion	handtag
Handtagsfärg	röd
Handtagsmaterial	PVC-U
Hus konstruktion	3-delt
Materialhus	PVC-U
Packningsmaterial	PTFE/EPDM
Anslutning	limsocket
Temperatur intervall	0°C - 60°C
Tryck	10 bar
Storlek	20 mm
Längd	84 mm
DN	15

DIMENSIONER

Ct-1 53.5 mm

Lb 84 mm

R 63 mm

ØDf 15 mm

ØDi-1 20 mm

ØDi-2 20 mm

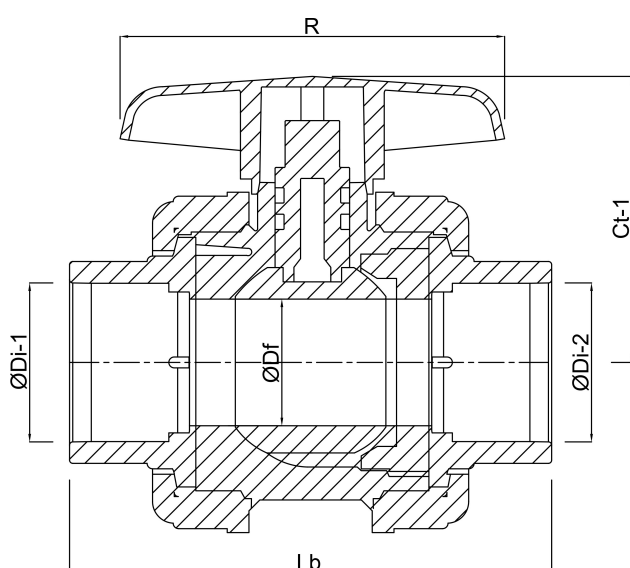

Genererad den: 23/05/2026

Bevo Nordic A/S
Pakhusgården 54
5000 Odense C
Danmark
+45 66 19 25 45
info@bevo.dk
<http://www.bevo.com>