

**Profec Gängad fläns stål
zinkpläterad DN15 x 1/2" DIN
fläns x invändig gänga DN15
PN10/16 (1080210)**



TEKNISKA SPECIFIKATIONER

Material	stål
Ytbehandling	zinkpläterad
Anslutning	DIN fläns x invändig gänga
DIN Standard	DIN 2566
Fläns	PN10/16
Storlek	DN15 x 1/2"
Bult	
DN	15
Diameter	21,3 mm
Yttre Ø	95 mm
Vikt	0.613 kg
Tjocklek	14 mm
Bulthål	14 mm
Hål	4

DIMENSIONER

O	14 mm
---	-------

PCD

65 mm

ØDi-1

1/2 "

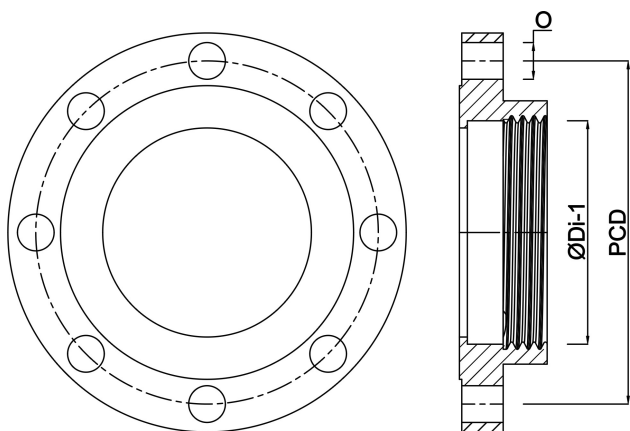

Genererad den: 24/05/2026

Bevo Nordic A/S
Pakhusgården 54
5000 Odense C
Danmark
+45 66 19 25 45
info@bevo.dk
<http://www.bevo.com>