

VDL Övergångsmuff PVC-U
50/63 mm x 2"
limsockel/limkoppling x
invändig gänga 10bar grå
(7002782)

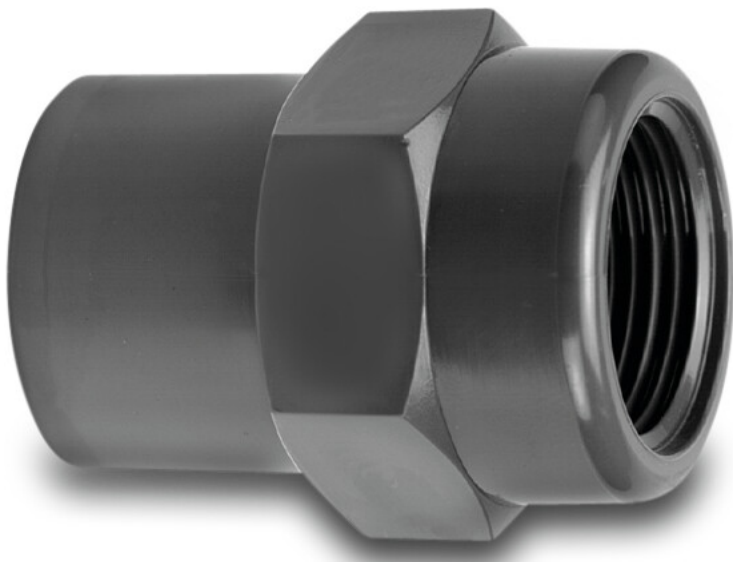

V-L Van de Lande

TEKNISKA SPECIFIKATIONER

Färg	grå
Material	PVC-U
Anslutning	limsockel/limkoppling x invändig gänga
Storlek	50/63 mm x 2"
Tryck	10 bar

DIMENSIONER

F-1	28 mm
L	92.5 mm
ØDi-1	2 "
ØDi-2	50 mm
ØDo-3	63 mm



Genererad den: 24/05/2026

Bevo Nordic A/S
Pakhusgården 54
5000 Odense C
Danmark
+45 66 19 25 45
info@bevo.dk
<http://www.bevo.com>