

# Hydro-S Vridspjäll PVC-U 75 mm fläns 10bar DN65 grå PN10 type 7500 (7014379)



  
hydro-s

# TEKNISKA SPECIFIKATIONER

Färg grå

Typ 7500

Material PVC-U

Funktion handtag

Handtagsfärg blå

Material ventil PVC-U

Spindelmaterial stål

Materialhus PP GF

Packningsmaterial EPDM

Anslutning fläns

Fläns PN10

Temperatur intervall 0°C - 40°C

Storlek 75 mm

DN 65

Bredd 46 mm

Tryck 10 bar

Bulthål 19 mm

## DIMENSIONER

Ct-1 179 mm

PCD 145 mm

R 207 mm

W-1 46 mm

W-2 115 mm

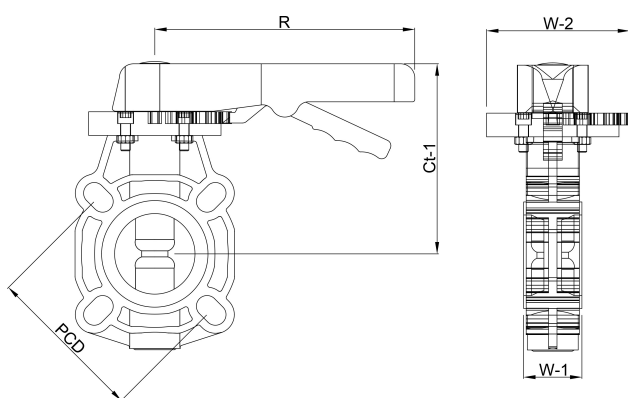

**Genererad den: 25/05/2026**

Bevo Nordic A/S  
Pakhusgården 54  
5000 Odense C  
Danmark  
+45 66 19 25 45  
[info@bevo.dk](mailto:info@bevo.dk)  
<http://www.bevo.com>