

**Profec Gängad fläns stål
zinkpläterad DN25 x 1" DIN
fläns x invändig gänga DN25
PN10/16 (1080212)**



TEKNISKA SPECIFIKATIONER

Material	stål
Ytbehandling	zinkpläterad
Anslutning	DIN fläns x invändig gänga
DIN Standard	DIN 2566
Fläns	PN10/16
Storlek	DN25 x 1"
Bult	
DN	25
Diameter	33,7 mm
Yttre Ø	115 mm
Vikt	1.1 kg
Tjocklek	16 mm
Bulthål	14 mm
Hål	4

DIMENSIONER

O	14 mm
---	-------

PCD

85 mm

ØDi-1

1 "

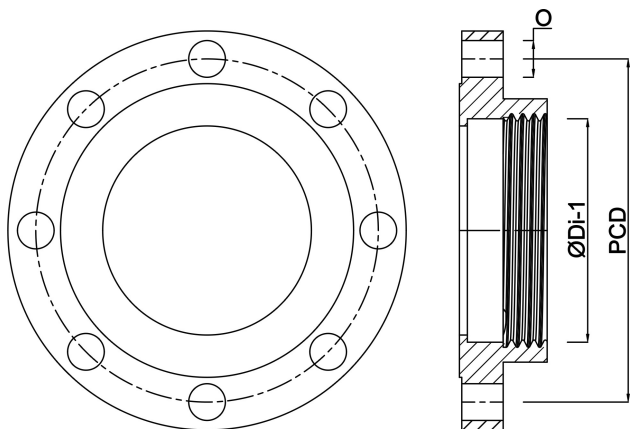

Genererad den: 24/05/2026

Bevo Nordic A/S
Pakhusgården 54
5000 Odense C
Danmark
+45 66 19 25 45
info@bevo.dk
<http://www.bevo.com>