

# Profec Svetsfläns stål DN150 x 168,3 mm DIN fläns x svetsning svart PN16 (1180488)



# TEKNISKA SPECIFIKATIONER

Färg svart

Material stål

Anslutning DIN fläns x svetsning

DIN Standard DIN 2633

Fläns PN16

Storlek DN150 x 168,3 mm

Yttre Ø 285 mm

Vikt 7.4 kg

Höjd 55 mm

Tjocklek 22 mm

PCD 240 mm

Bulthål 22 mm

Hål 8

# DIMENSIONER

O 18 mm

PCD 240 mm

ØDi-1

159.3 mm

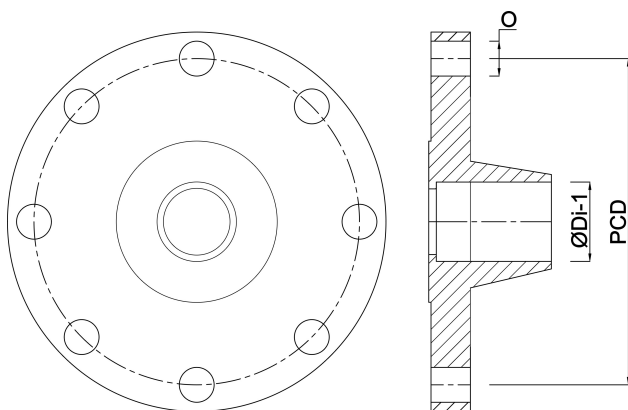

**Genererad den: 24/05/2026**

Bevo Nordic A/S  
Pakhusgården 54  
5000 Odense C  
Danmark  
+45 66 19 25 45  
[info@bevo.dk](mailto:info@bevo.dk)  
<http://www.bevo.com>