

Profec Fläns PVC-U DN50 x 2"
DIN fläns x invändig gänga
16bar DN50 grå PN10/16
(0111165)



TEKNISKA SPECIFIKATIONER

Färg	grå
Material	PVC-U
Anslutning	DIN fläns x invändig gänga
Fläns	PN10/16
Tryck	16 bar
Storlek	DN50 x 2"
DN	50
Yttre Ø	165 mm
Vikt	0.42 kg
Tjocklek	18 mm
Bulthål	18 mm
Hål	4

DIMENSIONER

O	18 mm
PCD	125 mm
ØDi-1	2"

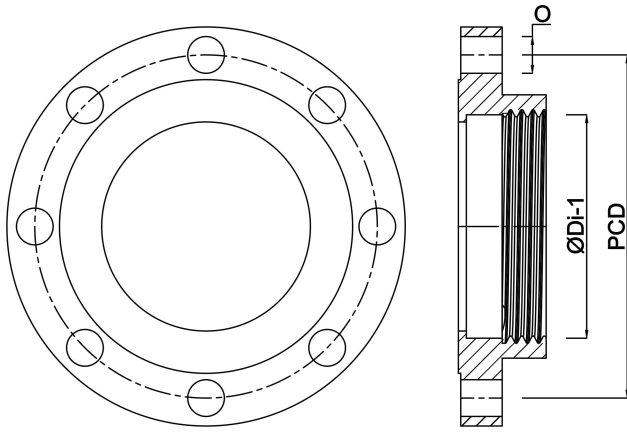

Genererad den: 23/05/2026

Bevo Nordic A/S
Pakhusgården 54
5000 Odense C
Danmark
+45 66 19 25 45
info@bevo.dk
<http://www.bevo.com>