

**Reduktionsmuff PVC-U 250  
mm x 200 mm limsocket 10bar  
grå type extruderad (0110688)**



# TEKNISKA SPECIFIKATIONER

Färg	grå
Typ	extruderad
Material	PVC-U
Anslutning	limsockel
Tryck	10 bar
Storlek	250 mm x 200 mm

## DIMENSIONER

L	365 mm
ØDi-1	250 mm
ØDi-2	200 mm

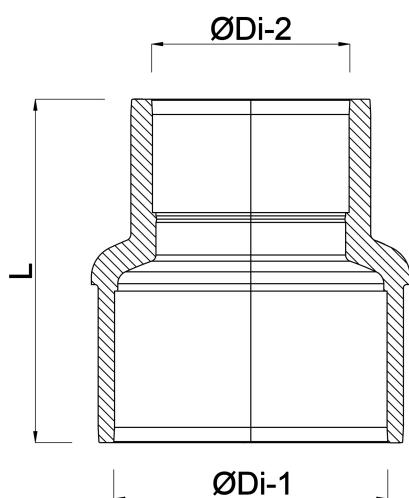

**Genererad den: 14/03/2026**

Bevo Nordic A/S  
Pakhusgården 54  
5000 Odense C  
Danmark  
+45 66 19 25 45  
[info@bevo.dk](mailto:info@bevo.dk)  
<http://www.bevo.com>